

CONVERSION FACTORS (AIP GEN 2.6 - 2)

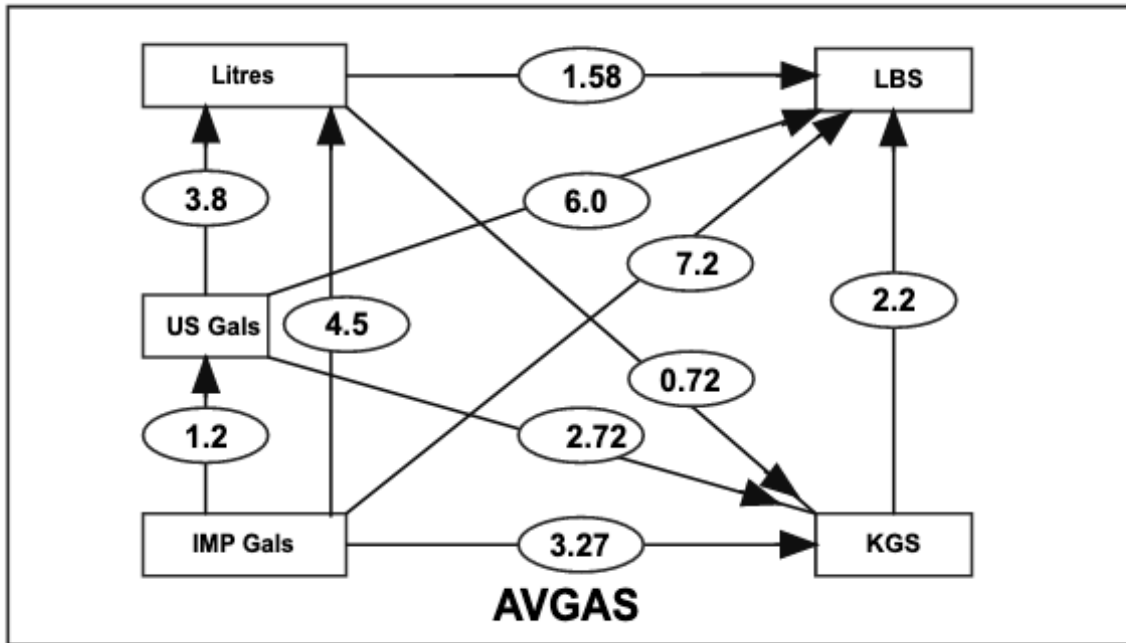

- To convert:
 - multiply** by the factor in the "balloon" when moving in the direction of the arrow, or **divide** by that factor if converting in the opposite direction.
- Fuel SG (0.8 AVTUR and 0.72 AVGAS) is based on ISA temperature at MSL. Therefore, fuel weights will be approximate for other than 15DEG Celsius.

HEAD & CROSSWIND COMPONENTS FOR RUNWAYS. (AIP GEN 2.6)

WIND COMPONENT TABLE		For crosswind component Angle Between Wind Direction and Runway Heading									
		10	20	30	40	45	50	60	70	80	90
W	5	1	2	2	3	4	4	4	4	5	5
I	10	2	3	5	6	7	7	8	9	9	10
N	15	3	5	7	9	11	11	13	14	14	15
D	20	3	7	10	13	14	15	17	18	19	20
	25	4	8	12	16	18	19	22	23	24	25
S	30	5	10	15	19	21	23	26	28	29	30
P	35	6	12	17	22	25	26	30	32	34	35
E	40	7	14	20	25	28	30	35	37	39	40
E	45	8	15	22	29	32	34	39	42	44	45
D	50	9	17	25	32	35	38	43	47	49	50
	55	10	19	27	35	39	42	48	52	54	55
K	60	10	20	30	38	42	46	52	56	59	60
N	65	11	22	32	42	46	50	56	61	64	65
O	70	12	24	35	45	49	54	60	66	69	70
T	75	13	26	37	48	53	57	64	70	73	75
S	80	14	27	40	51	57	60	69	75	78	80
		80	70	60	50	45	40	30	20	10	0
		For Headwind Component Angle Between Wind Direction and Runway Heading									

TAKE-OFF WEIGHT CHART TYPE ONE

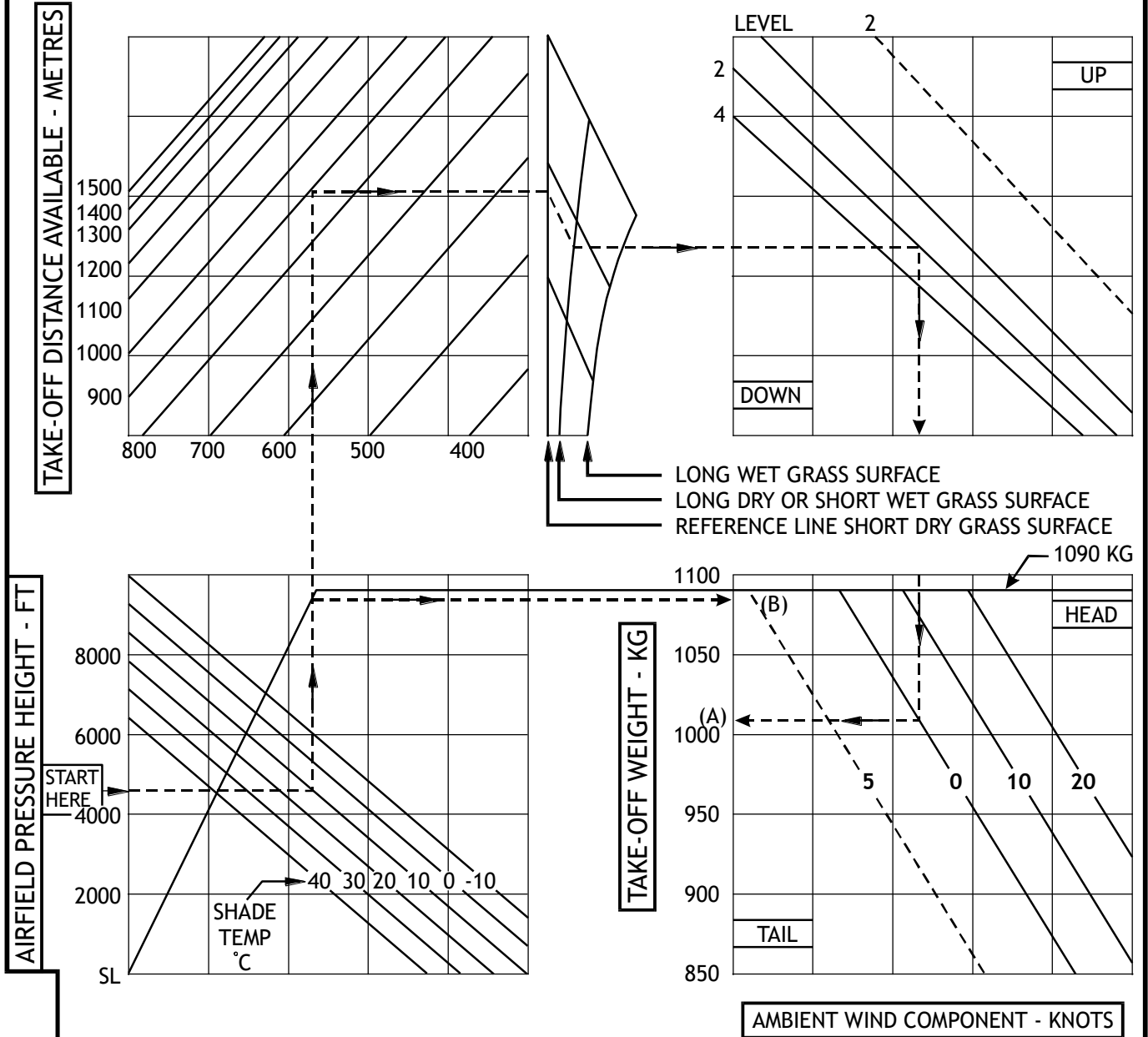

NOTES:

- (1) THE GROSS WEIGHT AT TAKE-OFF SHALL NOT EXCEED THE LESSOR OF (A) AND (B).
- (2) THE MAXIMUM TAKE-OFF WEIGHT = 1090 KG

POWER TO BE USED	FULL THROTTLE
FLAP SETTING	10 DEGREES
TAKE-OFF SAFETY SPEED	60 KIAS
TAKE-OFF DISTANCE FACTOR	1.15
MAX PERMITTED CROSS WIND	15 KTS

LANDING CHART TYPE ONE

LANDING DISTANCE REQUIRED - METRES

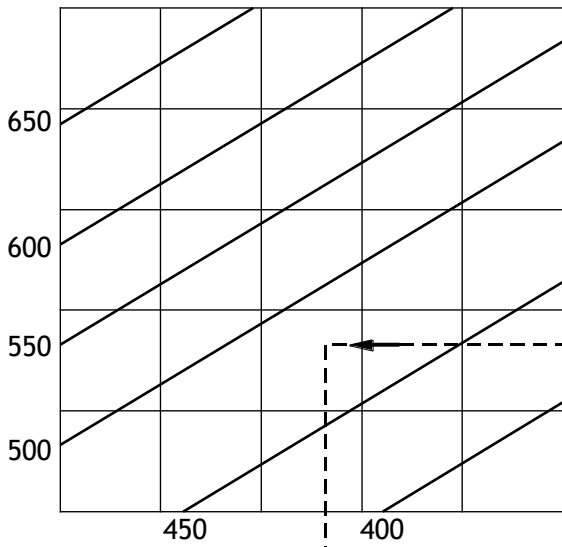

SLOPE PERCENT

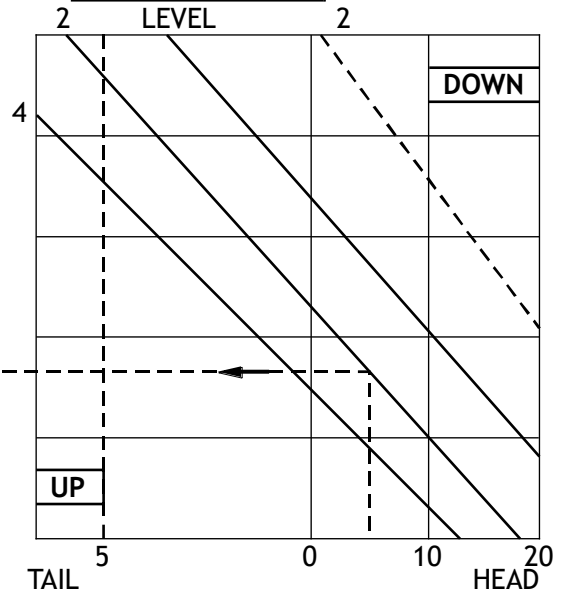

AIRFIELD PRESSURE HEIGHT - FT

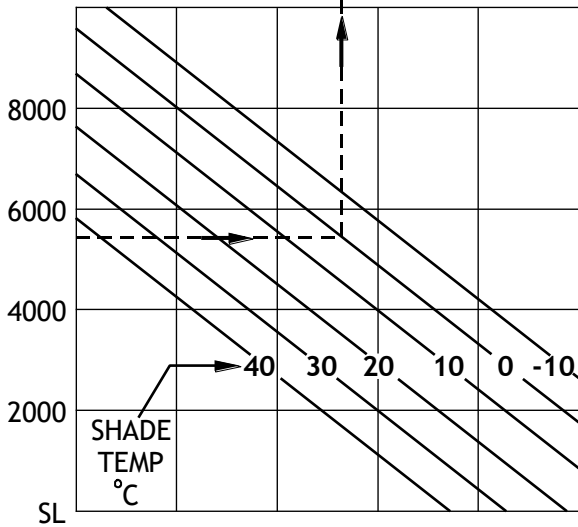

AMBIENT WIND COMPONENT - KNOTS

AIRFIELD PRESSURE HEIGHT - FT

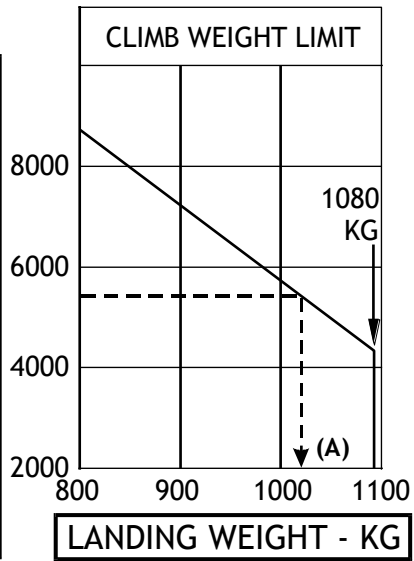

NOTES:

- (1) THE GROSS WEIGHT AT LANDING SHALL NOT EXCEED (A).
- (2) LANDING DISTANCE REQUIRED DOES NOT VARY SIGNIFICANTLY WITH WEIGHT

FLAP SETTING	30 DEGREES
APPROACH SPEED	58 KIAS
LANDING DISTANCE FACTOR	1.15
MAX PERMITTED CROSS WIND	15 KTS

LINEAR LANDING DISTANCE CHART

FLAP SETTING 40 DEGREES
 APPROACH SPEED 65 KT IAS
 LANDING DISTANCE FACTOR 1.15
 MAX PERMITTED CROSS WIND 15 KTS

NOTE:
 LANDING DISTANCE REQUIRED
 IS INDEPENDENT OF LANDING
 WEIGHT.

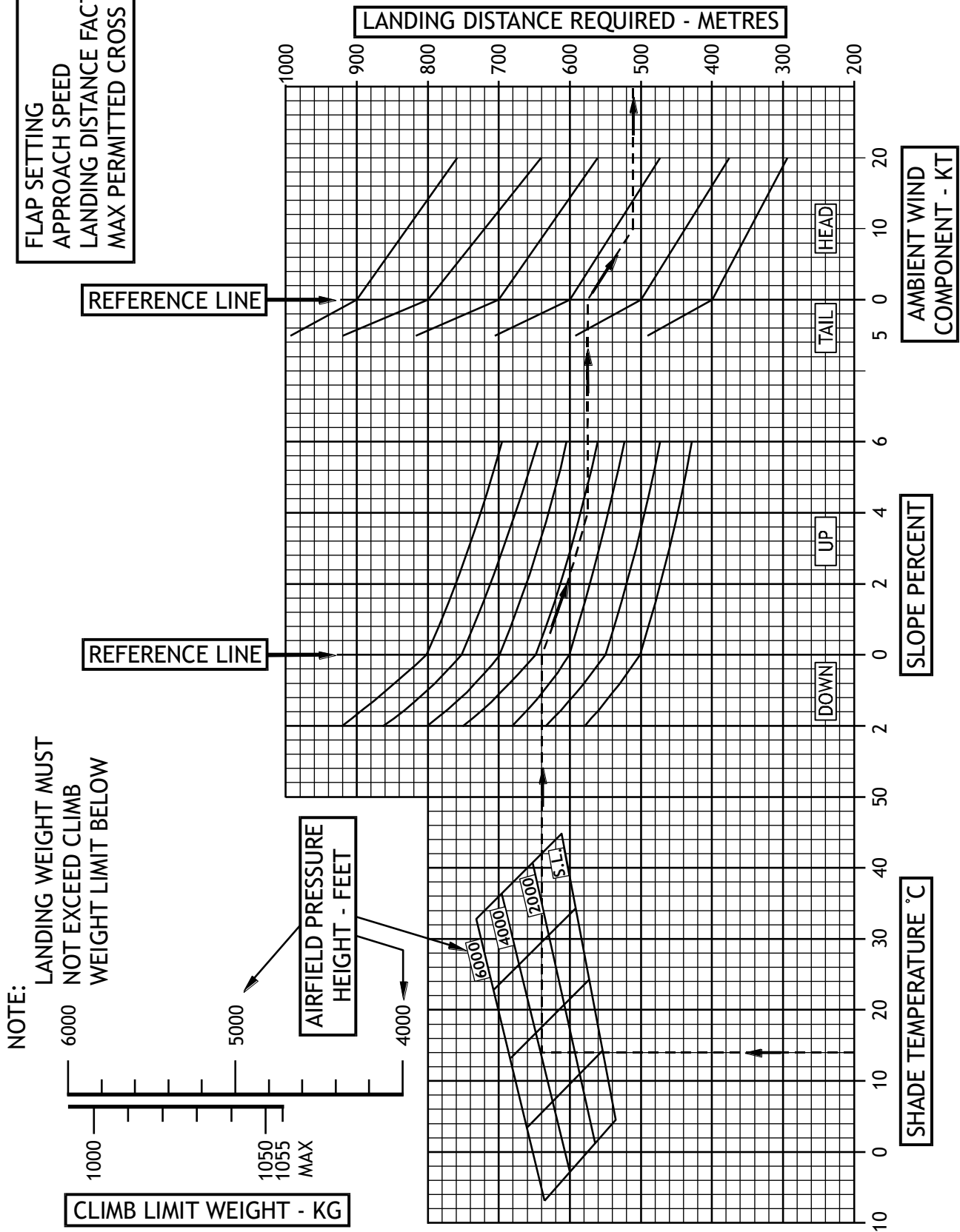

LINEAR TAKE-OFF WEIGHT CHART

TAKE-OFF DISTANCE REQUIRED - METRES

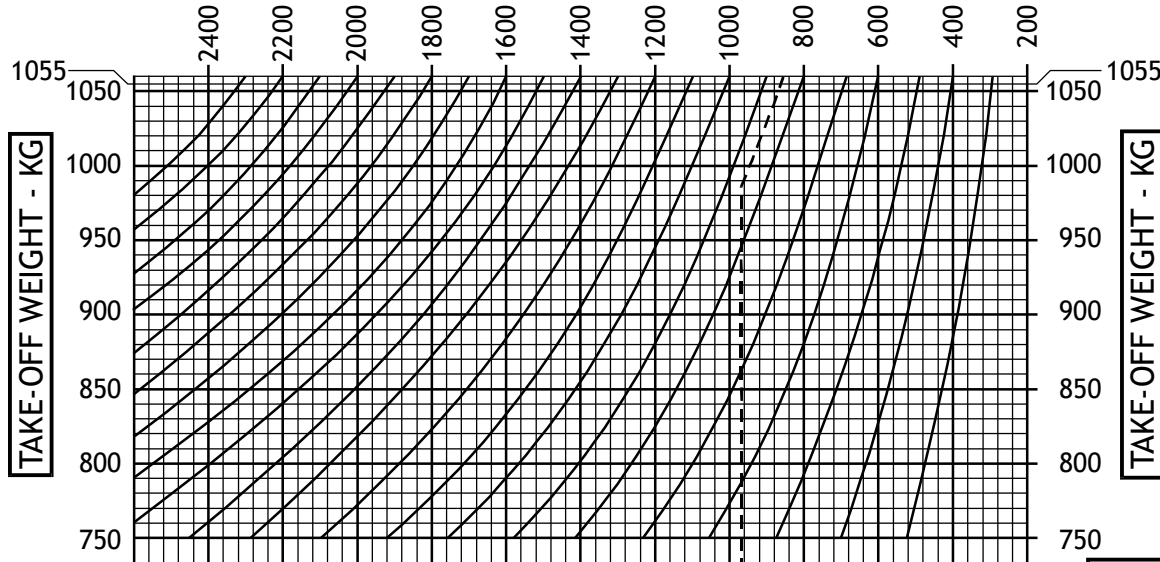

REFERENCE LINE

REFERENCE LINE

LONG WET GRASS

SHORT WET OR LONG DRY GRASS

SHORT DRY GRASS

REFERENCE LINE HARD SEALED SURFACE

TAKE-OFF WEIGHT - KG

AMBIENT WIND COMPONENT - KT

SLOPE PERCENT

SURFACE

SHADE TEMPERATURE °C

- FLAP SETTING ZERO
- TAKEOFF SAFETY SPEED 64 KT IAS
- POWER SETTING FULL THROTTLE
- RPM NOT LESS THAN 2350
- CHART DISTANCE FACTOR 1.15
- MAX PERMITTED CROSS WIND 15 KTS

NOTE: TAKEOFF WEIGHT MUST NOT EXCEED CLIMB WEIGHT LIMIT BELOW

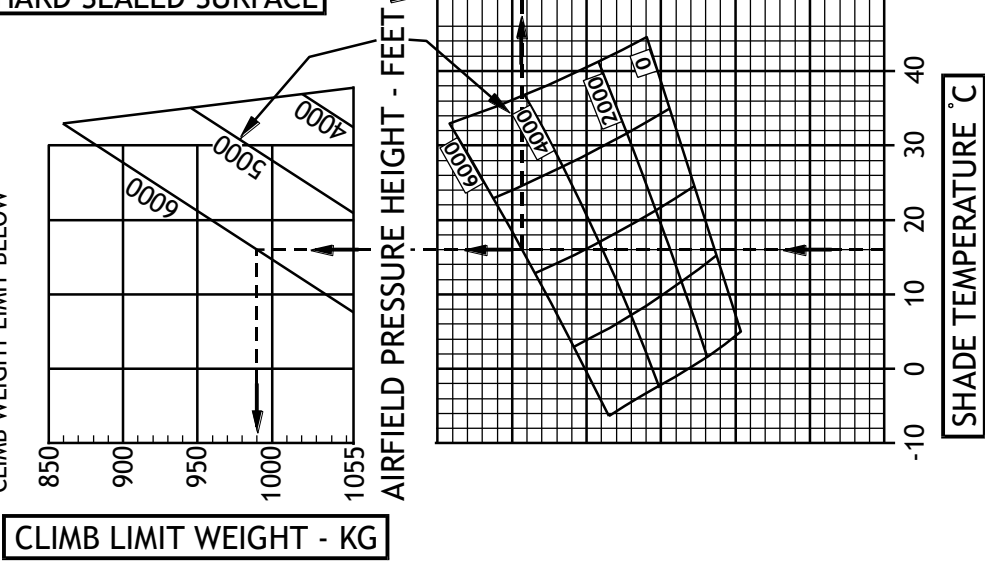

CLIMB LIMIT WEIGHT - KG

LOADING SYSTEM ALPHA
CONFIGURATION: 6/7 SEATS

INSTRUCTIONS FOR USE OF LOADING SYSTEM

- 1 Obtain Basic Empty Weight and Index Units from current Section of 6.2 of Flight Manual.
- 2 Mark Basic Empty Weight Index Units on top scale. Enter Basic Empty Weight at top of right-hand column.
- 3 Enter weights of load items required for flight in appropriate squares of right-hand column. Maximum weights for load items are indicated on Index Unit scales.
- 4 Total weights in right-hand column to obtain Zero Fuel Weight and Take-Off Weight. **
- 5 Draw horizontal lines on CG Envelope graph corresponding to Zero Fuel Weight and Take-Off Weight.
- 6 Draw a line vertically down from point marked on Basic Empty Weight Index Units scale to first load item scale.
* Move to the left or right on this load item index scale as per arrow directions, and mark point as appropriate to the load indicated in the right-hand column.
(e.g. 154 KG load @ 77 KG/div. = 2 div.).
- 7 Draw a line vertically down from the point marked on the first load item index scale to the second load item index scale and continue as per * above. Continue down the scales to "Rear Baggage". Draw a line vertically from the "Rear Baggage" point down to intersect the Zero Fuel Weight line and Take-Off Weight line previously marked on the CG envelope graph.
- 8 The two intersection points as per 7, above must not exceed the boundaries of the CG envelope graph. If they do, re-organise the load in the aircraft and start again with steps 3 to 7.

**** DO NOT EXCEED MAXIMUM TAKE-OFF WEIGHT AS SHOWN ON CG ENVELOPE DIAGRAM OF THIS LOADING SYSTEM.**

EXAMPLE:

Basic Empty Weight	1050 KG
Empty Index units	-260
Row 1	150 KG (2 persons)
Row 2 (forward facing)	160 KG (2 persons)
Row 3	120 KG (2 persons)
Nose baggage	40 KG ----- Zero Fuel Wt = 1520 KG
Rear baggage	Nil
Fuel	113 KG ----- Take-Off Wt = 1633 KG

Note: Basic Empty Weight includes unusable fuel and full oil.

LOADING SYSTEM ALPHA

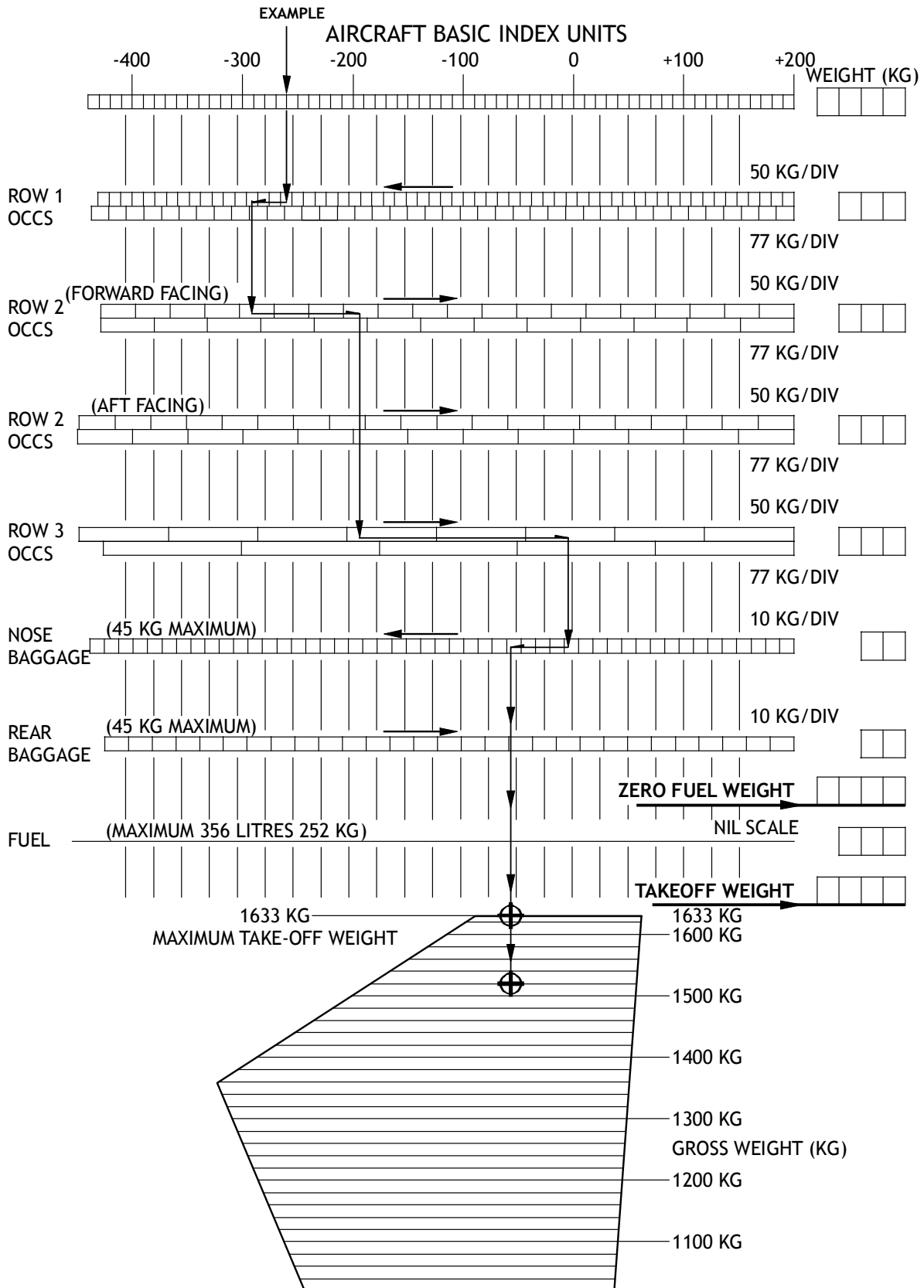

LOADING SYSTEM BRAVO
CONFIGURATION: 4 SEATS

INSTRUCTIONS FOR USE OF LOADING SYSTEM

To check the loading of the aircraft before take-off, calculate the total weight and total moments as shown in the example below.

Plot the total weight and moment on the “Centre of Gravity Envelope” chart, and if the intersection point is within the envelope, the loading is acceptable.

AIRCRAFT LIMITATIONS

Maximum take-off weight

Normal category: 1000 KG / 2200 lbs

Utility category: 841 KG / 1850 lbs

Maximum cargo compartment: 154 KG / 339 lbs

Maximum baggage compartment: 54 KG / 120 lbs

Notes:

- 1 The aircraft is fitted with standard tanks (37 US Gallons at 6 lbs / gallon)
- 2 Empty weight includes unusable fuel and undrainable oil
- 3 Obtain Moment / 1000 inch pounds from the loading graph

EXAMPLE:

	WEIGHT (LBS)	ARM (IN)	MOMENT/1000 IN LB
Empty weight	1260	80	100.80
Oil	15	32	.48
Pilot & Co-Pilot	320	91	29.12
Cargo compartment	80	115	9.20
Rear seat passengers	250	126	31.50
Baggage	25	151	3.78
Zero Fuel Weight	1950		174.88
Fuel (140 litres)	221	91	20.11
Take-Off Weight	2171		194.99

Check CG is within the envelope at both ZFW and Take-off weight

Note: The graph titled LOADING SYSTEM BRAVO on the next page is relic of the days before the availability of calculators. Enter at the load in pounds on the left axis, move horizontally to the loading station line, then move vertically down to extract the moment index on the bottom horizontal axis.

A far simpler method of obtaining the moment generated by any weight in any particular location is simply to multiply the weight in pounds by the arm in inches from the example table above and then divide by 1000. That table will be found in the Examination Workbook supplied in the exam.

Example: 25 pounds placed in the cargo compartment would create a moment index of 3.78.

$$25 \times 151 \div 1000 = 3.78$$

LOADING SYSTEM BRAVO

Add weight of items to be carried to aeroplane licensed empty weight. Add moment/1000 of items to be carried to total aeroplane moment/1000. Use Centre of Gravity Envelope to determine acceptability.

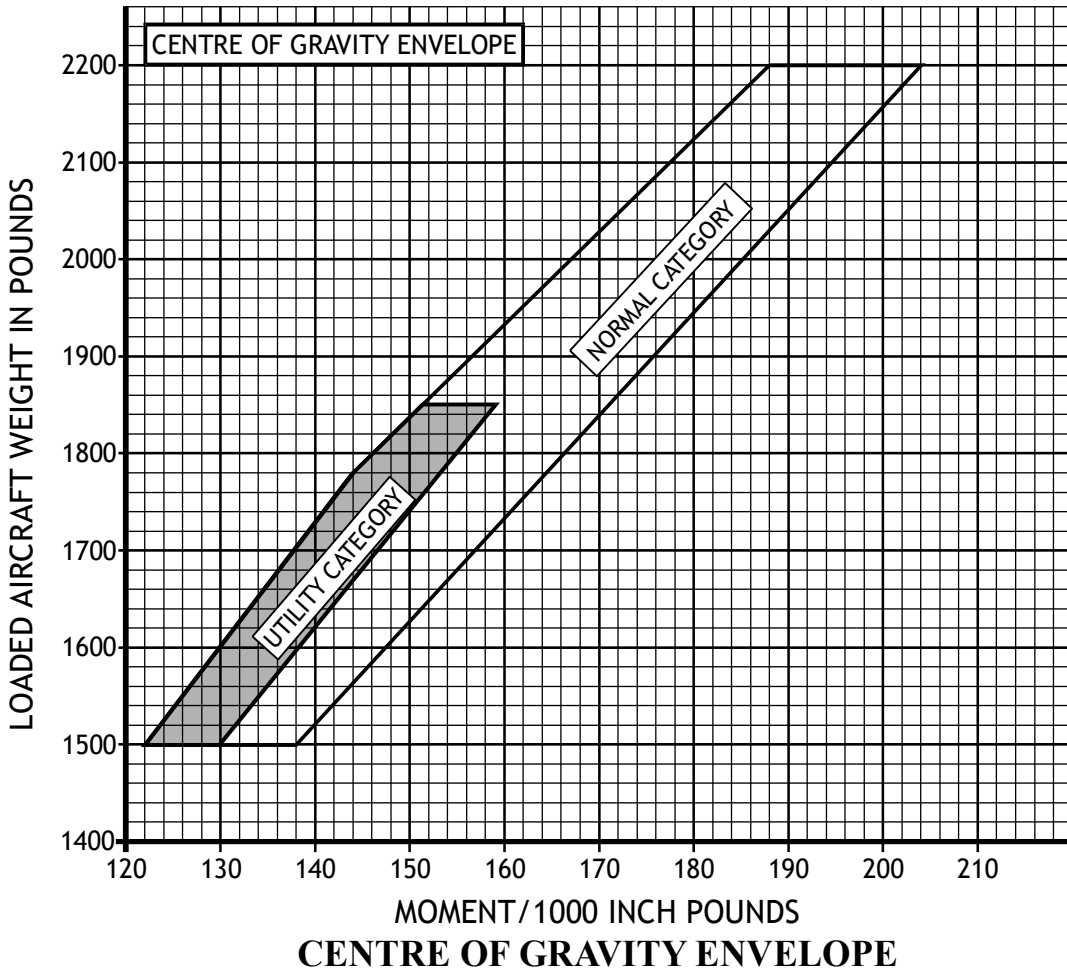
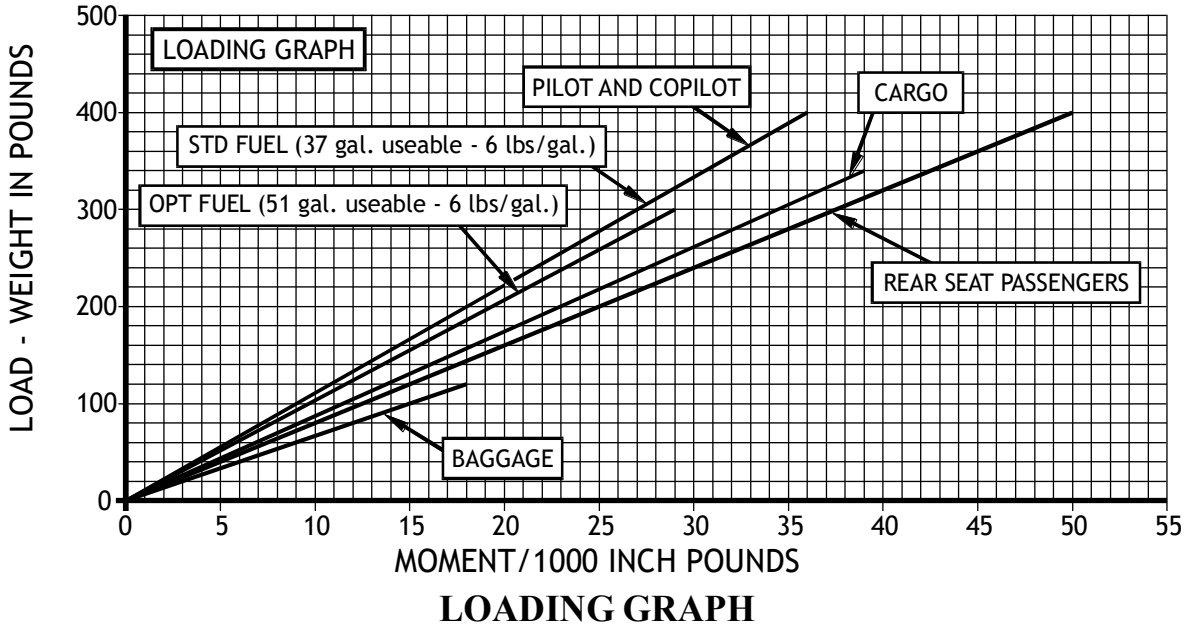

LOADING SYSTEM CHARLIE
CONFIGURATION: 4 SEATS

INSTRUCTIONS FOR USE OF LOADING SYSTEM

To check the loading of the aircraft before take-off, carry out a summation of weight and index units as shown in the example below. Check the centre of gravity of the aircraft at Zero Fuel Weight and Take-Off Weight by use of the formula:

$$\text{CG (mm aft of datum)} = \frac{\text{Index unit} \times 100}{\text{Weight}}$$

The CG must be within the envelope given at all times.

AIRCRAFT LIMITATIONS

Maximum take-off weight	
Normal category:	1115 KG
Utility category:	925 KG
Maximum baggage compartment baggage:	122 KG

Notes:

- 1 Aircraft empty weight includes unusable fuel and undrainable oil
 - 2 All arms are in mm aft of datum
 - 3 1 index unit = 100 KG mm
-

EXAMPLE:

	KG	IU
Aircraft empty weight	687	19,522
Full oil	7	86.1
1 pilot + 1 passenger Row 1	140	3,850
2 passengers Row 2	160	5,760
Baggage	20	842
Zero Fuel Weight	1014	30,060.1
Fuel 140 litres	100.8	2,973.6
Take-off Weight	1114.8	33,033.7

- CG check
1. At Zero Fuel Weight = $(30,060.1 \times 100) / 1014 = 2964.51$ mm OK
 2. At Take-Off Weight = $(33,033.7 \times 100) / 1114.8 = 2963.20$ mm OK

Arm for row 1	2750 mm	Arm for row 2	3600 mm
Arm for engine oil	1230 mm	Arm for fuel tanks	2950 mm
Arm for baggage	4210 mm		

LOADING SYSTEM CHARLIE

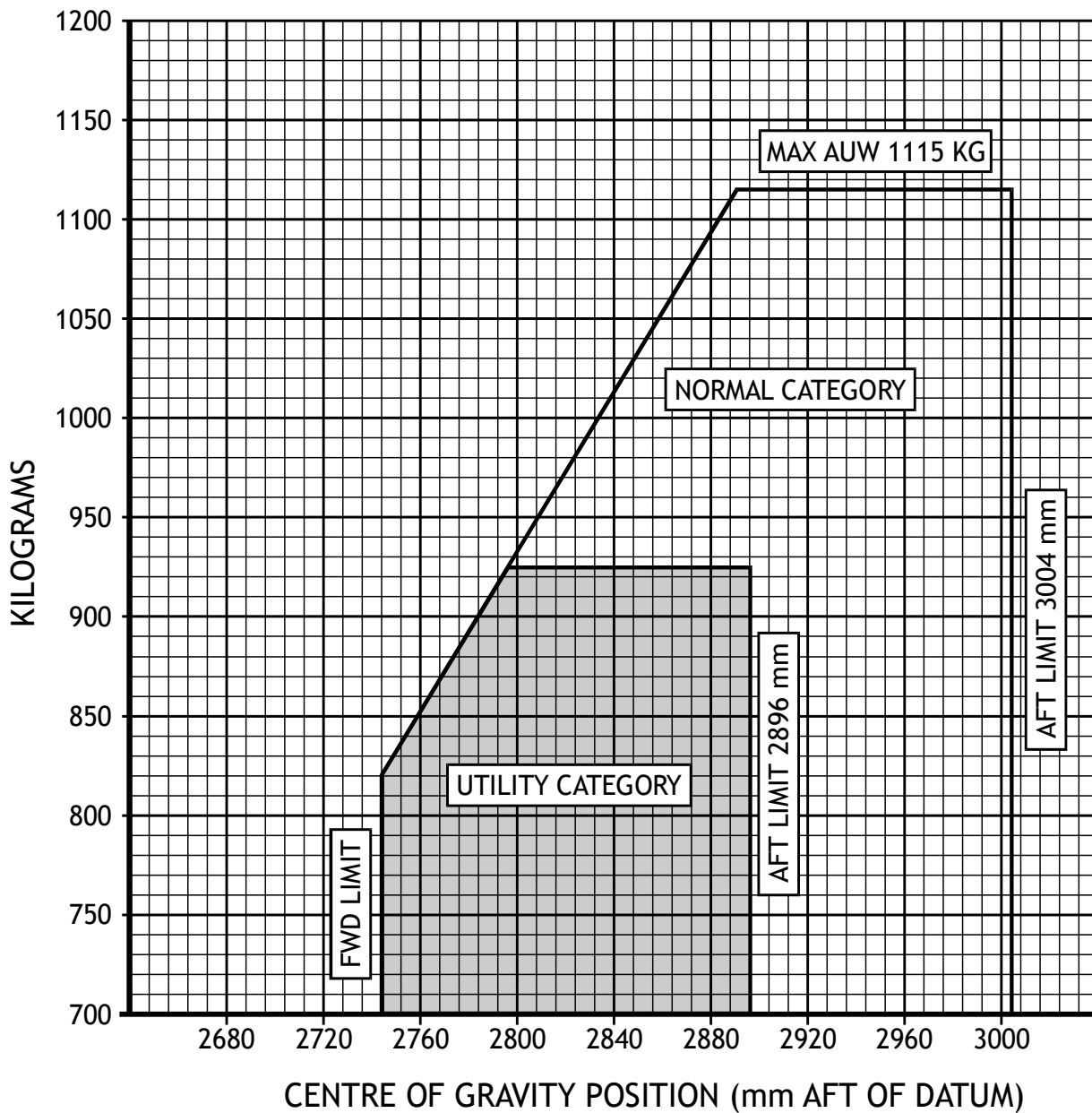

ALLOWABLE CENTRE OF GRAVITY ENVELOPE

CONVERSION FACTORS

1 inch = 25.4 mm

1 foot = 0.305 metre

1 lb = 0.454 KG

1 Imp gal = 1.201 US gal = 4.546 litres

AVGAS Specific Gravity = 0.72 Kg/Litre

COMPANY POLICY

EXTRACT FROM COMPANY OPERATIONS MANUAL FOR THE ECHO AEROPLANE

Fuel Reserves

Fuel reserves [for all flights] shall be carried in accordance with CASR Part 91 MOS 19.02 Table 19.02 (2)

The fuel reserve recommended for a small piston-engine VFR Air Transport Flight is-

Final Reserve Fuel to allow 30 mins over the destination for private flights.

Final Reserve Fuel to allow 45 mins over the destination for air transport flights*.

Contingency Fuel equal to 10% of the trip fuel for air transport flights*.

Final Reserve Fuel for the ECHO aeroplane is calculated at 20 gal/hr.

Start-up and Taxi fuel allowance for the ECHO aeroplane is 3 gal.

**See Part 135 MOS Chapter 7 para 7.02 refers to air transport flights.*

For the sake of exercises in this book the fuel reserves and allowances for the Echo aeroplane should be according to the instructions on Page 14 of this supplement unless the question specifies otherwise.

The data presented in paragraphs

2.1, 2.3, 3.1, 3.2, 4.2, 4.4, and 4.5

may be required for exercises and tests contained in the CPL Performance Book.

The CASA exam will provide this type of information in the individual question texts.

PERFORMANCE DATA FOR THE ECHO AEROPLANE.

NOTE THAT IN THE CASA EXAM YOU WILL NOT BE GIVEN THE
FUEL POLICY,
RATE OF CLIMB, TAS OR FUEL FLOW TABLES.

THESE ITEMS WILL SIMPLY BE STATED IN THE QUESTION TEXT.

The Echo is a twin engine, six place unpressurised aircraft. It is fitted with fuel injected, turbo charged engines with fully feathering constant speed propellers. The aircraft is equipped with oxygen to allow flight at any level up to and including 20,000 feet. It has four separate cargo compartments the details of which are given on Page 18.

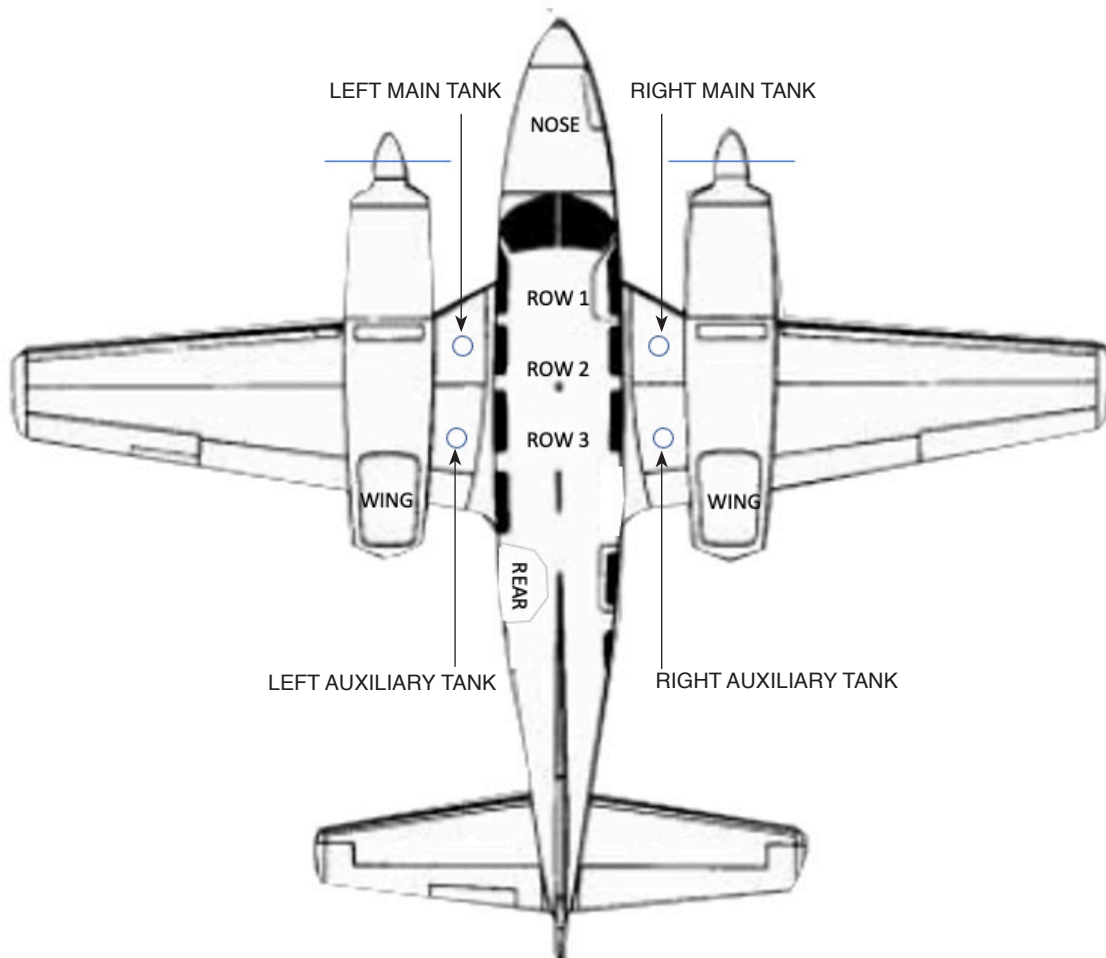

Removal of seats for freight operations.

The cabin seats are easily removable and may be stowed in the rear compartment or left at the departure aerodrome to increase the volumetric capacity of the cabin.

AIRCRAFT FUEL CAPACITY

2.1 Two main and two auxiliary fuel tanks are fitted.

	Usable Fuel US Gallons	Unusable Fuel US Gallons	Total Fuel US Gallons
MAIN TANKS:			
Left	50	2	52
Right	50	2	52
AUXILIARIES			
Left	40	3	43
Right	40	3	43
TOTAL	180	10	190

2.2 The specific gravity of the fuel is 0.72, and the weight of all unusable fuel and all engine oil is included in the aircraft's Basic Empty Weight.

THE ECHO AEROPLANE FUEL POLICY FOR EXERCISES IN THIS BOOK. (CASR Part 135 Chapter 7 para 7.02)

- 2.3 Allowance for start-up and taxi is.....3 US Gallons
 Reserves [for all flights]
 Contingency fuel.....10% of trip fuel
 Final Reserve Fuel [45 minutes minutes @ 20 US Gal/Hr.....15 US Gallons
 Holding Fuel when requiredat 45% MCP*
 * See para 4.5 for fuel flow figures.

Trip fuel is the fuel calculated to be consumed from take-off to arriving over the top of the destination aerodrome. For the purpose of examination questions, make no allowance for climbs or descents.

- 2.4 When refuelling the main tanks should be filled to capacity first. The auxiliary tanks should be used only if the required fuel cannot be accommodated in the mains.
- 2.5 Use MAIN TANKS for start-up, taxi, take-off, climb and descent. Once in cruise, the AUXILIARY TANKS should be selected and all auxiliary fuel should be used before the main tanks are used.

Operating Limitations:

- 3.1 Never Exceed Speed [Vne].....230 kt IAS
 Normal Operating Speed [Vno or Maximum Structural Cruising].....199 kt IAS
 Maximum Flaps Extended [Vfe].....156 kt IAS
 Landing Gear Extended [Vle].....139 kt IAS
 Single engine Minimum Control Speed [Vmc].....75 kt IAS
 Manoeuvring Speed [Va or Maximum Control Deflection].....160 kt IAS
 Maximum cross wind component.....20kt
 Maximum downwind component take-off or landing.....5kt

3.2 Engine Limitations.

	Take-off Power Power [limit of 3 minutes]	Maximum Continuous
Maximum RPM	3200	3200
Manifold Pressure	37.4 “Hg	34.5”Hg
Mixture	Rich	Rich
Brake Horse Power	375 per engine	340 per engine

3.3 Maximum Crosswind Component for take-off or landing.....20 kt.

3.4 Maximum Tailwind Component for take-off or landing.....5 kt

Performance Data.

4.1 Take off and Landing performance is given in the form of ‘P’ charts within this manual. The Echo is not to be operated into or out of any landing area that does not meet the performance limitations obtained by the use of these charts. For any sealed or gravel surface, the ‘short dry grass’ reference line on the take-off chart should be used.

4.2 Maximum Climb Performance [Maximum Rate of Climb]. Use 100% MCP. The maximum climb performance expected at various combinations of Pressure Height and Gross Weight is given in the table below. Note that the performance given assumes ISA conditions. If temperature deviates from ISA, density height should be used instead of pressure height.

MAXIMUM RATE OF CLIMB Gross Weight - TWO ENGINES

Pressure Height ISA feet.	2950		2500		2000 kg	
	TAS	ROC	TAS	ROC	TAS	ROC
Sea level	101	1600	92	2250	82	2950
5000	109	1500	99	2100	88	2800
10000	118	1400	107	1950	95	2650
15000	128	1300	116	1800	104	2500
20000	139	800	126	1250	112	1800

MAXIMUM RATE OF CLIMB Gross Weight - ONE ENGINE

Pressure Height ISA feet.	2950 kg		2500 kg		2000 kg	
	TAS	ROC	TAS	ROC	TAS	ROC
Sea level	105	280	97	525	92	780
5000	112	200	103	450	98	700
10000	120	100	111	360	106	625
15000	129	20	119	270	115	530

4.3 The Cruise Climb chart.

The cruise climb chart shown below gives the distance, time and fuel required to climb in no wind from sea-level to various pressure heights under various temperature and gross weight conditions. The temperatures given at the bottom of the left-hand box are the temperatures *at* the pressure height to which the climb is being made.

An allowance for wind can be made by calculating the distance represented by the wind speed applied to the duration of the climb. [eg a wind speed of 30 kt for a six minute climb would represent a distance of 3 nm]. This distance should be added to the distance obtained from the graph for a tailwind, and subtracted for a headwind. The time and fuel required for any given climb will not be affected by wind.

The most accurate method for obtaining the figures for a climb from an aerodrome at other than sea level [eg from 5000 ft to 15000 ft], is to calculate the set of figures from sea-level to 15000 ft, then calculate the set of figures from sea-level to 5000 ft and subtract the 5000 ft figures from the 15000 ft figures.

Power to be used for cruise climb is 75% MCP with mixture rich.
Climbing Indicated Airspeed for a cruise climb is 120kt.

CRUISE CLIMB - TWO ENGINES

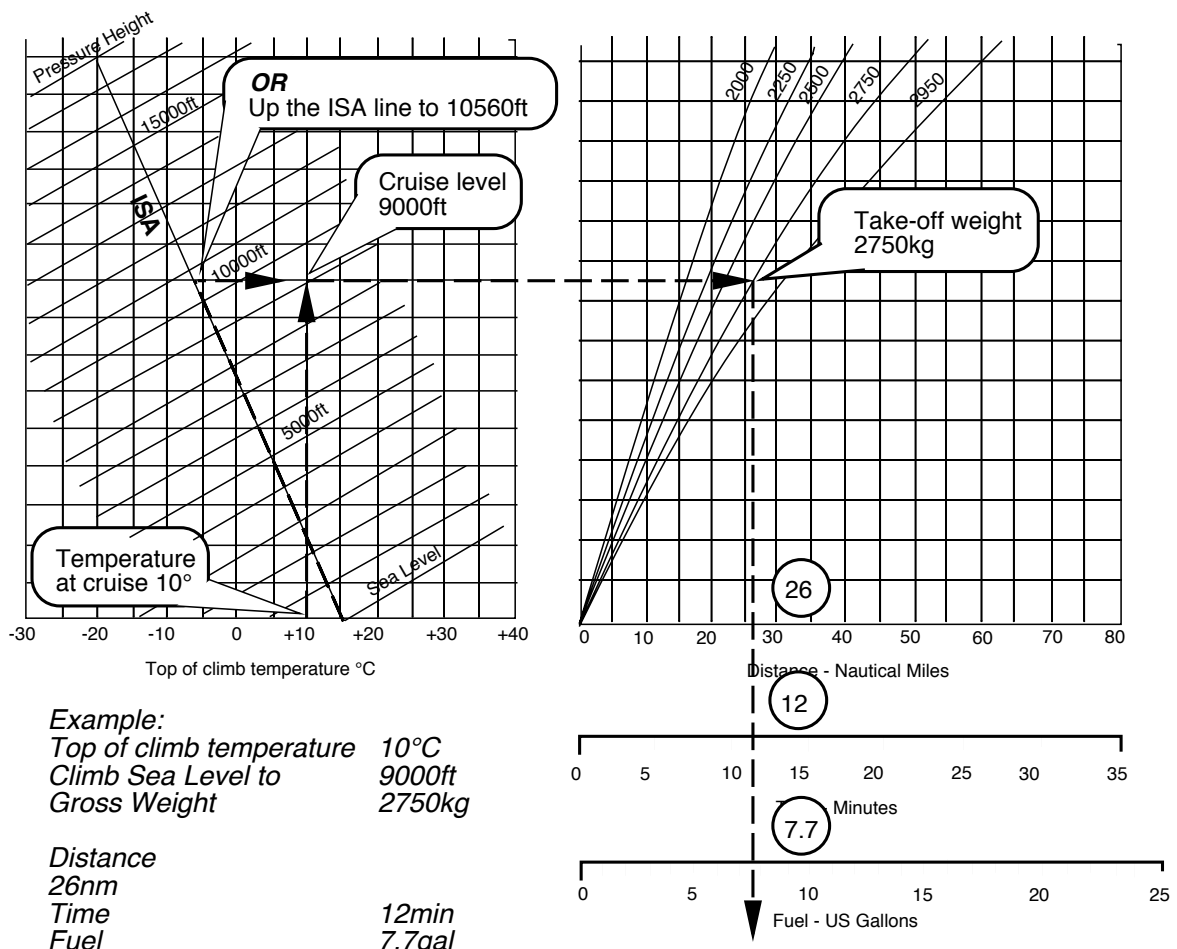

NOTE THAT IN THE CASA EXAM YOU WILL NOT BE GIVEN THE TAS TABLE. THE TAS TO USE WILL SIMPLY BE GIVEN IN THE QUESTION DATA.

4.4 The TAS that may be planned for cruise at various pressure heights, temperatures, gross weights and power settings are shown in the table below.

TAS knots GROSS WEIGHT																
Press Ht	Temp	2950kg					2500kg					2000kg				
		75%	65%	55%	45%	35%	75%	65%	55%	45%	35%	75%	65%	55%	45%	35%
SL	ISA - 20	177	165	156	142	116	180	168	159	145	118	184	171	161	149	120
5000		185	172	160	145	116	188	172	163	147	119	192	178	166	151	121
10,000		193	179	165	147	117	196	182	168	150	119	201	185	171	153	122
15,000		201	185	165	147	116	204	189	173	152	117	209	193	177	155	120
20,000		209	193	174	150	----	213	197	178	154	----	217	201	182	157	----
SL	ISA	181	168	158	144	116	184	171	161	146	118	188	174	164	149	121
5000		189	175	162	146	117	192	178	165	148	119	198	181	169	152	122
10,000		197	182	166	148	117	200	185	170	151	119	205	189	174	154	122
15,000		205	189	171	150	114	208	192	176	154	116	213	196	184	156	118
20,000		213	198	177	151	----	217	201	180	154	----	221	208	189	157	----
SL	ISA + 20	185	171	160	145	116	187	174	163	147	119	191	177	166	151	121
5000		192	178	166	145	116	195	181	166	150	119	200	185	171	153	122
10,000		200	185	170	149	116	204	188	173	152	118	208	192	176	155	121
15,000		209	193	173	151	----	212	196	178	154	----	217	200	182	157	----
20,000		216	201	179	149	----	221	205	183	152	----	225	209	186	155	----

NOTE: THE CASA EXAM WILL NOT GIVE YOU THE FUEL FLOW TABLE. THE FUEL FLOW TO USE WILL SIMPLY BE GIVEN IN THE QUESTION DATA.

4.5 The fuel flow that can be planned for various power settings is shown in the table below. Fuel flow depends only on the engine power output and is unaffected by the aircraft gross weight and cruising level.

The mixture should be leaned to best economy at all power settings except for 100% and take-off power, or during cruise climbs or as a means of controlling engine overheating.

FUEL FLOWS PER ENGINE IN US GALLONS PER HOUR		
Engine Power % MCP.	Mixture leaned to best economy.	Mixture fully rich.
100%	not available	31.7*
75%	16.3	19.7
65%	14.0	16.9
55%	11.8	14.1
45%	10.2	11.8
35%	8.6	9.3
*100% power is not available above 15,000 feet.		

THE FOLLOWING WEIGHT AND BALANCE DATA WILL BE SUPPLIED IN THE EXAMINATION WORKBOOK PROVIDED IN THE CASA EXAMINATION.

LOADING SYSTEM ECHO

INSTRUCTIONS FOR USE OF LOADING SYSTEM

- 1 Obtain the aeroplane basic empty weight and index units from the examination question. Multiply the weight (in kg) in each compartment by the arm (in mm) of that compartment to obtain the moment in kg/mm. Divide the moment in kg/mm by 10000 to obtain the corresponding moment index (index units).
- 2 Add up the required total weight (Gross Weight) of the aeroplane and the corresponding Total Moment Index.
- 3 Refer to the Centre of Gravity chart (Figure 11, page 19). Locate the Gross Weight of the loaded aeroplane (in KG) on the vertical scale and move horizontally to meet the vertical line representing the Total Moment Index of the loaded aeroplane. If the point of intersection, which represents the Centre of Gravity, falls in the shaded area, the aeroplane is correctly loaded.

Note: The Centre of Gravity must lie in the shaded area at ALL stages of flight.

Weight Limitations:	Maximum Take-off Weight	2950 KG
	Maximum Landing Weight	2725 KG
	Maximum Zero Fuel Weight	2630 KG

Balance Data:	The Mean Aerodynamic Chord (MAC) data is as follows:	
	Length of chord	1900 mm
	Location of leading edge	2190 mm aft of datum

Centre of Gravity range is as follows:
 2400 mm to 2680 mm at 2360 KG or less
 2560 mm to 2680 mm at 2950 KG
 Linear variation between the points given

Loading Data:

<u>Location</u>	<u>Maximum Permissible Load</u>	<u>Load Arm (mm Aft of Datum)</u>
Seating:		
Row 1 (Seats 1 & 2)	Pilot + 1 Passenger	2290
Row 2 (Seats 3 & 4)	2 Passengers	3300
Row 3 (Seats 5 & 6)	2 Passengers	4300
Cargo & Baggage		
Compartments (Compts):		
Forward Compt	55 KG	500
Left wing Compt	55 KG	3550
Right wing Compt	55 KG	3550
Rear Compt	155 KG	5000
Floor loading intensity	(All Compts) 450 KG/m ²	
Fuel:		
Left main tank	50 gal	1780
Right main tank	50 gal	1780
Left auxiliary tank	40 gal	2800
Right auxiliary tank	40 gal	2800

ECHO WEIGHT TO MOMENT CONVERSION

This graph allows you to determine the moment (in index units) generated by placing weight in any compartment of the ECHO aeroplane.

Example: 150kg placed in Row 2 will generate a moment index of just under 50 index units.

A much simpler way to find the moment is to use your calculator. Multiply the weight by the compartment arm and divide by 10,000. In the example below:

$$150\text{kg} \times 3300\text{mm} \div 10,000 = 49.5 \text{ index units.}$$

I recommend that you use the calculator rather than the graph below to obtain moment index.

LOADING SYSTEM ECHO

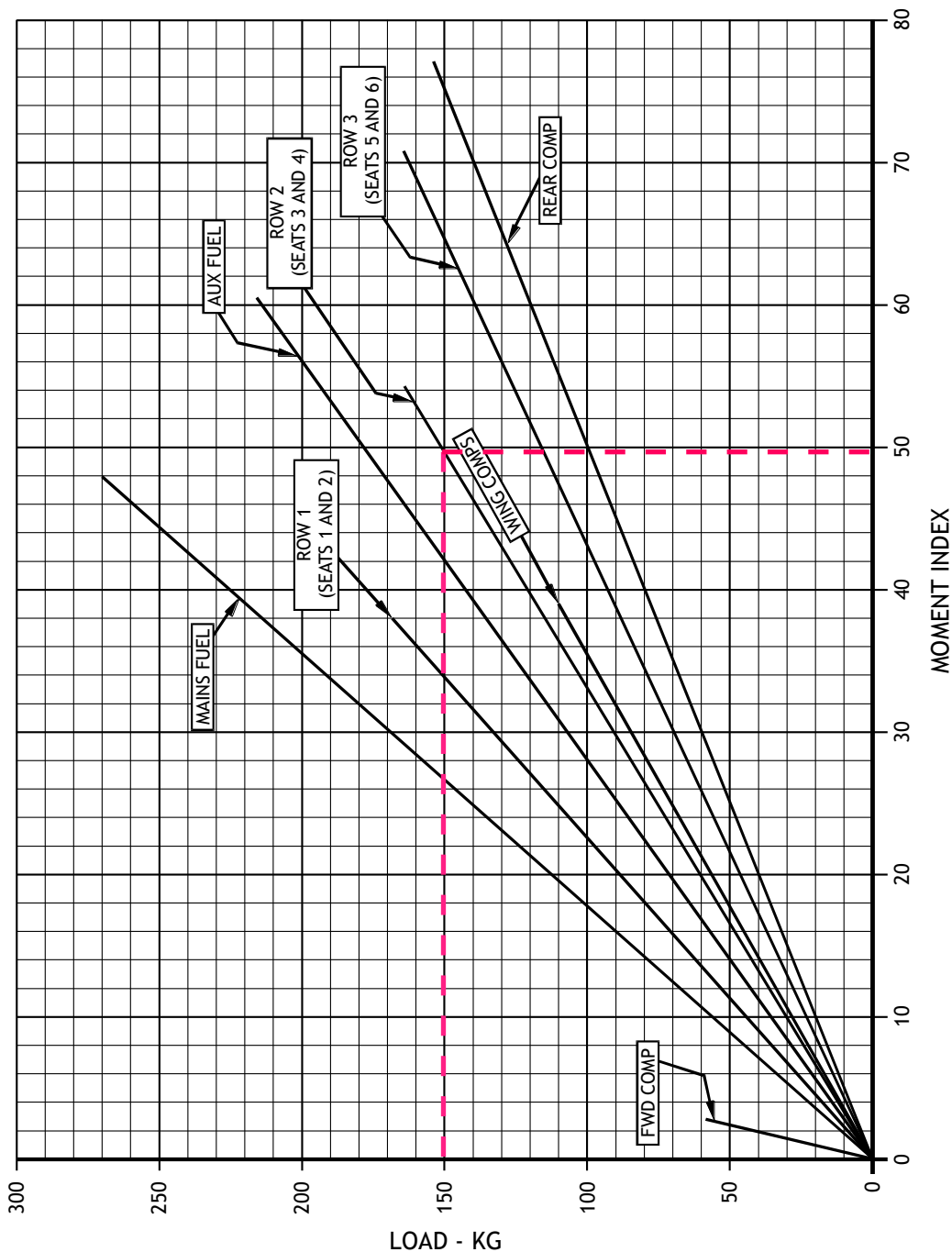

LOADING SYSTEM ECHO

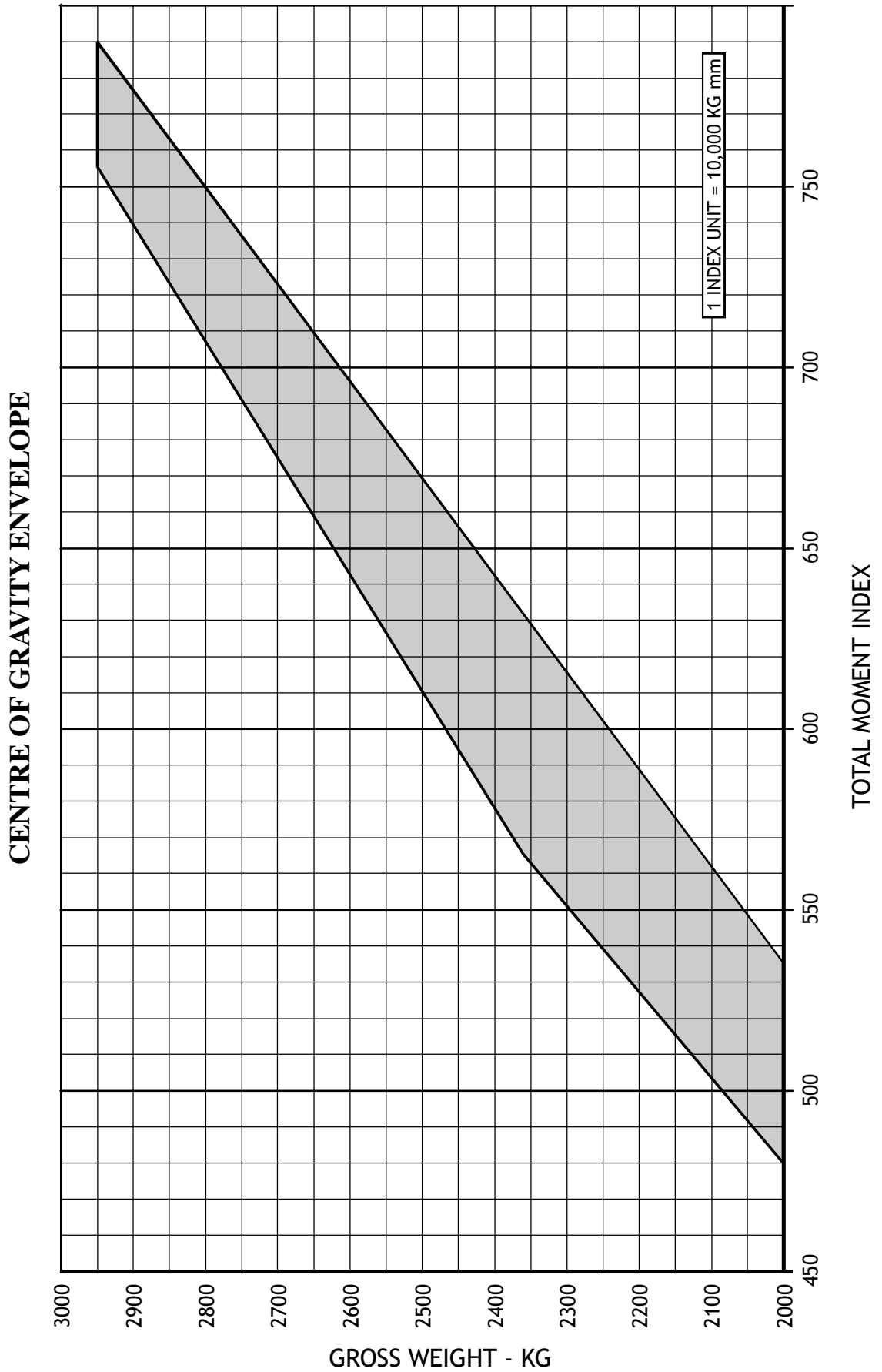

LANDING WEIGHT CHART AIRCRAFT - ECHO

FLAP SETTING	45 DEGREES
APPROACH SPEED	SEE SCALE
DISTANCE FACTOR	1.26
MAX PERMITTED CROSS WIND	20 KTS

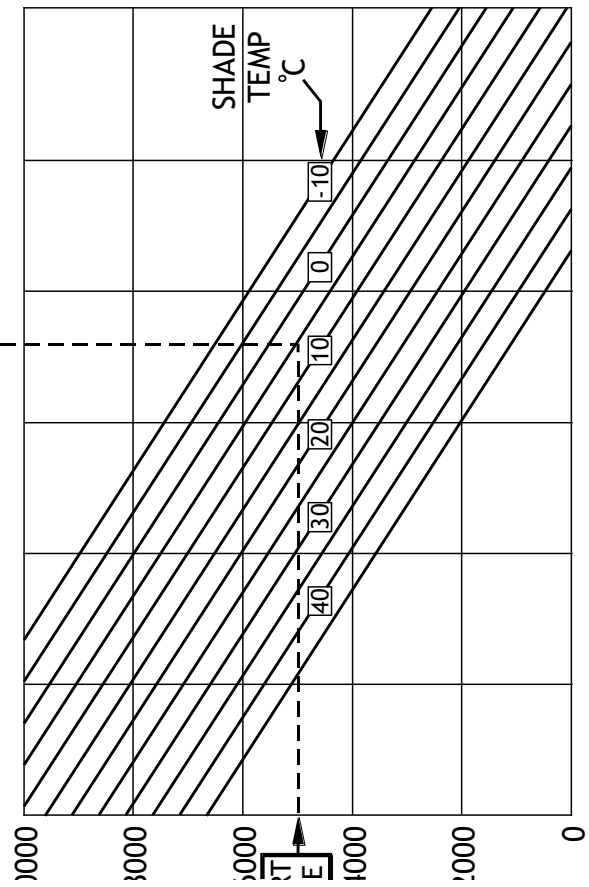
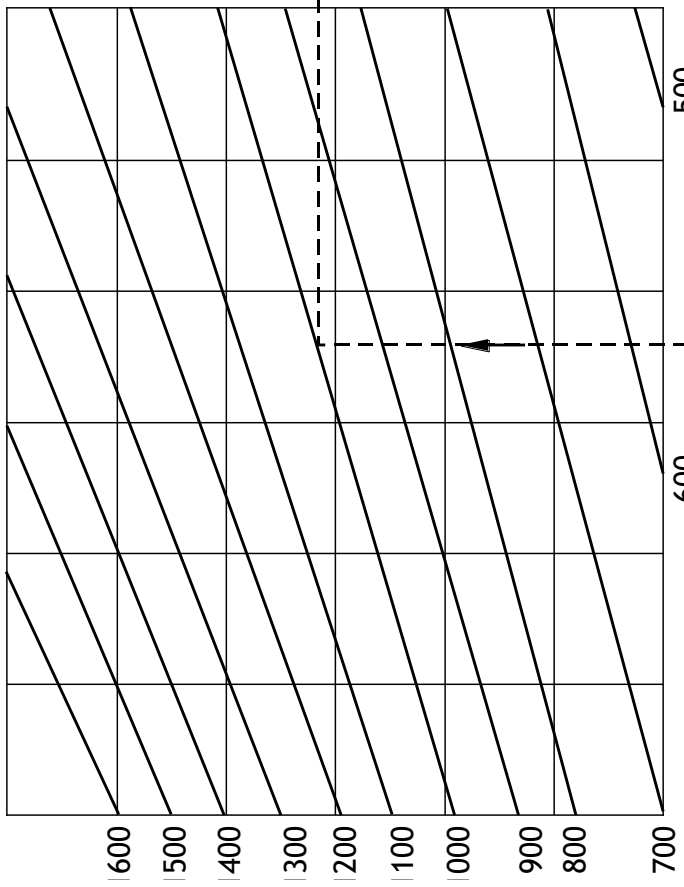
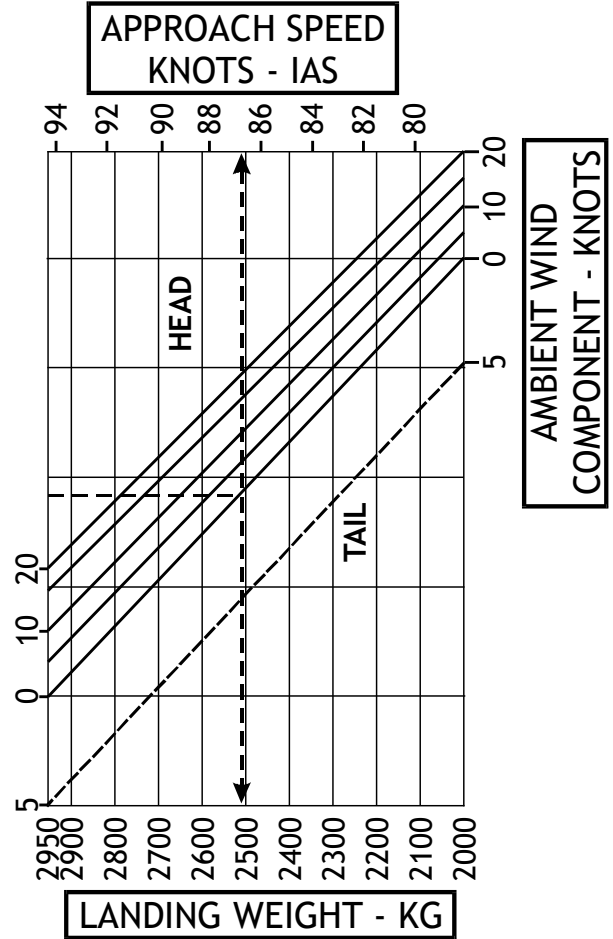
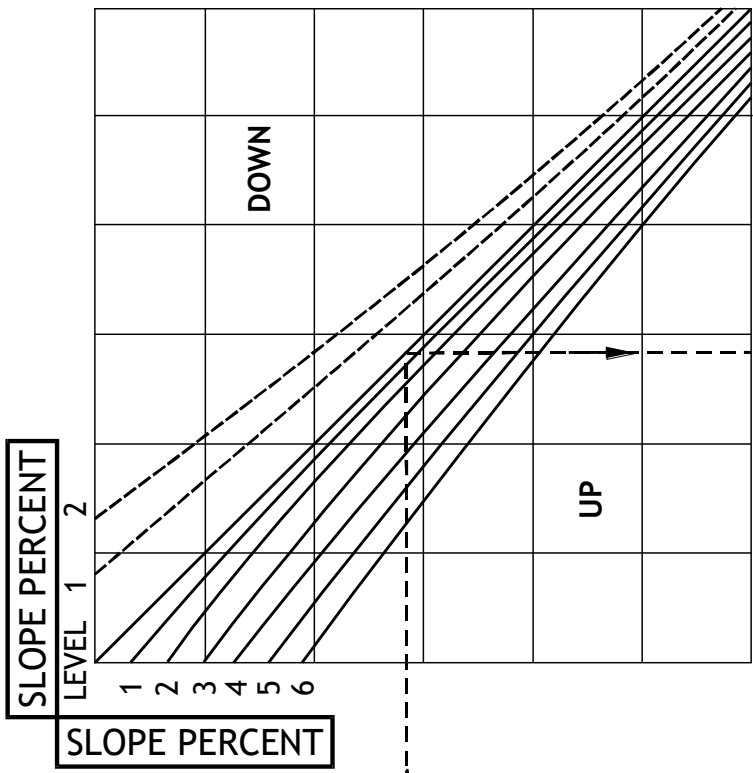

FLAP SETTING ZERO DEGREES
 TAKE-OFF SAFETY SPEED SEE SCALE
 DISTANCE FACTOR 1.22
 POWER TO BE USED RPM 3200 RPM
 MAN PRESS 37.4 IN Hg
 MAX PERMITTED CROSS WIND 20 KTS

TAKE-OFF WEIGHT CHART AIRCRAFT - ECHO

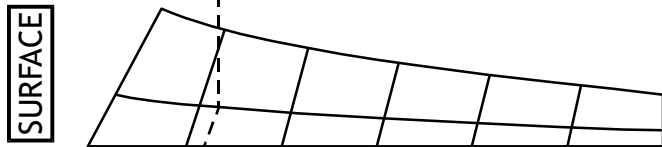
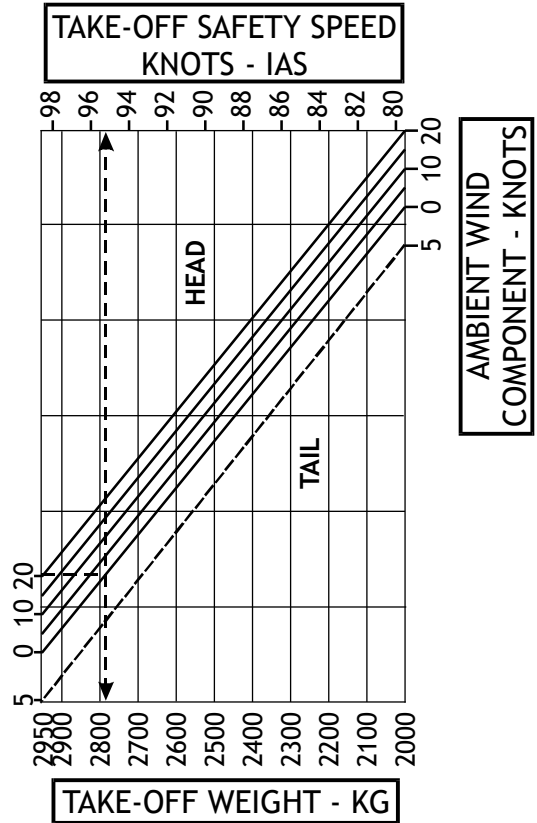
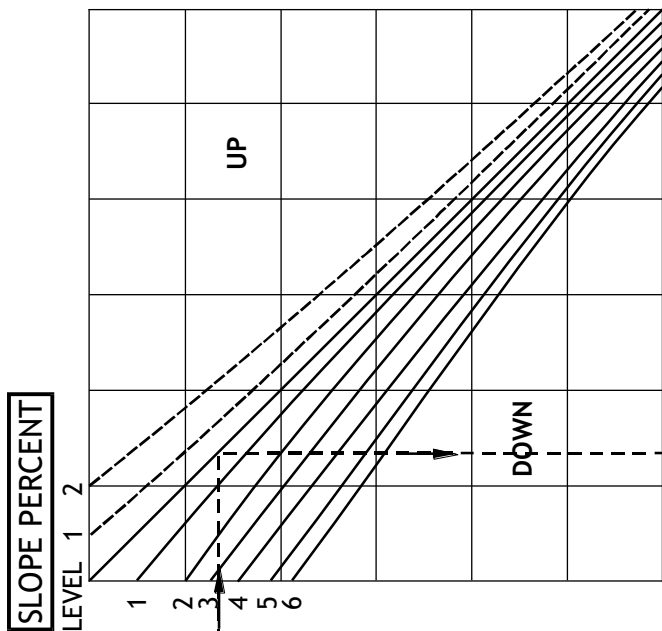

LONG WET GRASS
 SHORT WET OR LONG DRY GRASS
 REFERENCE LINE - SHORT DRY GRASS

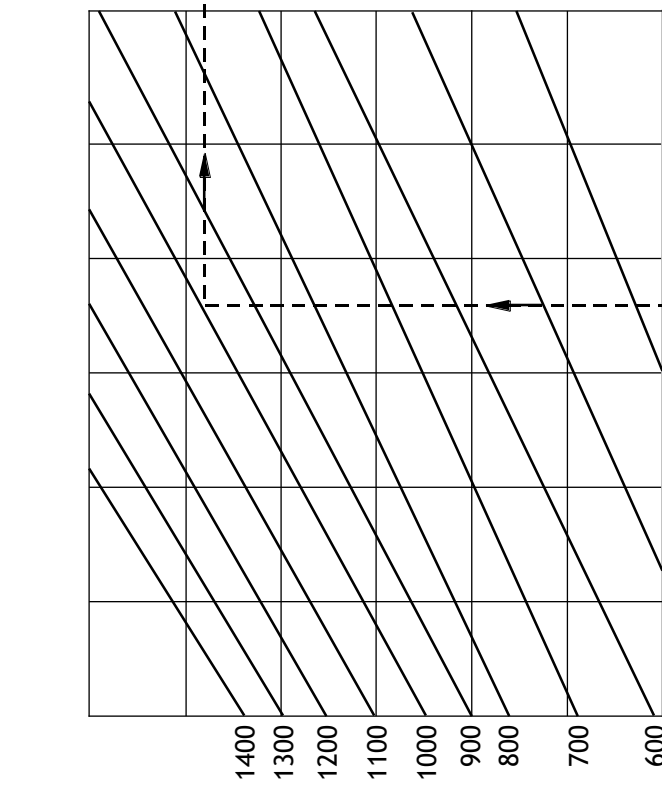

TAKE-OFF DISTANCE
 AVAILABLE - METRES

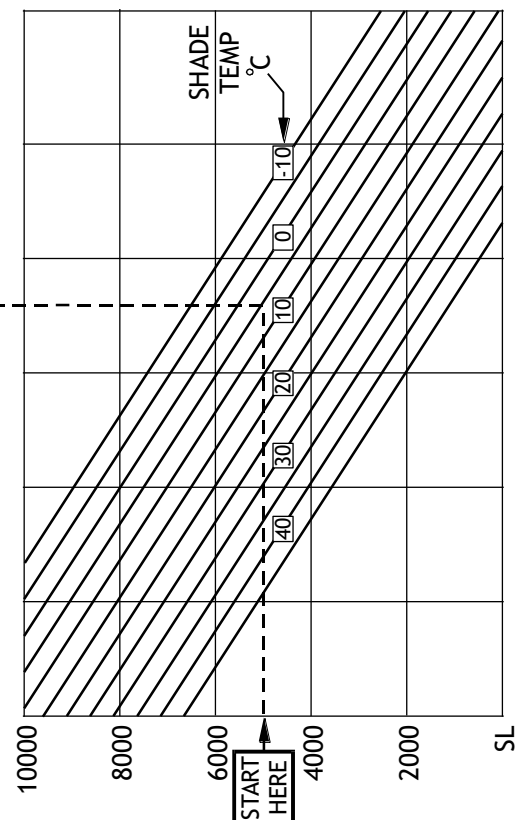

AIRFIELD PRESSURE
 HEIGHT - FEET

